

自動調心滾子軸承

内徑 130~160 mm

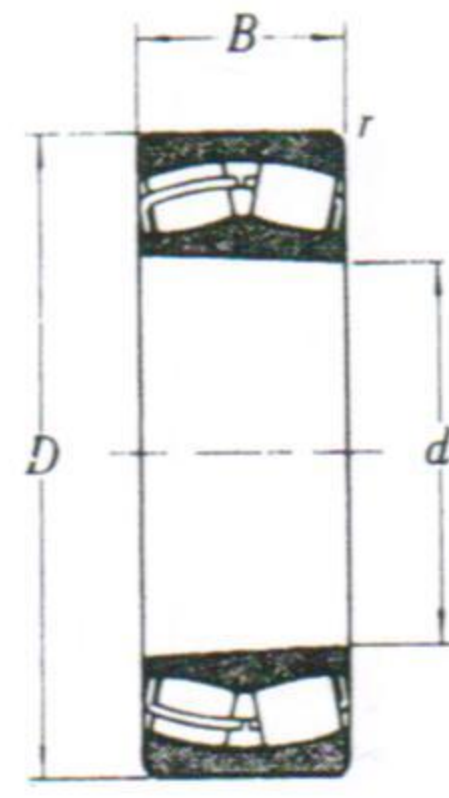
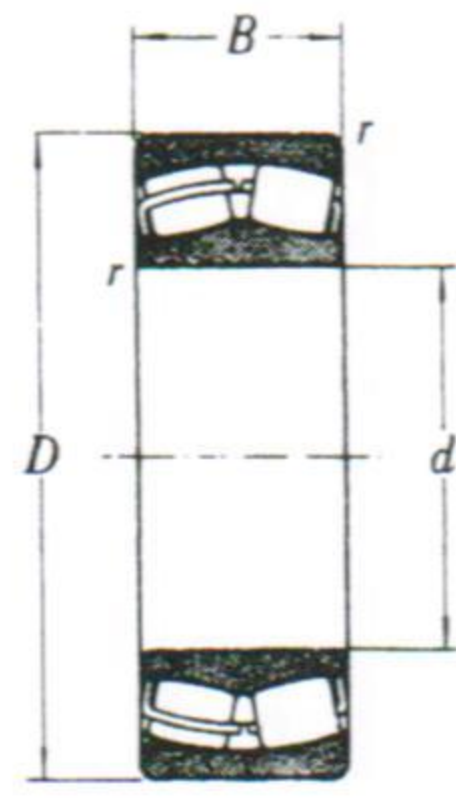

錐形内孔

付油孔・油溝

主要寸法(mm)				基本型號		基本定格荷重(kgf)		極限速率(rpm)	
d	D	B	r	圓形内孔	錐形内孔	C	Co	脂潤滑	油潤滑
130	200	52	3	23026 CD	23026 CDK	35500	41500	1600	2000
	200	69	3	24026 CA	24026 CAK30	44000	54500	1400	1700
	210	64	3	23126 CA	23126 CAK	44500	52500	1300	1700
	210	80	3	24126 CA	24126 CAK30	52000	64000	1300	1700
	230	64	4	22226 CD	22226 CDK	50500	52500	1500	1900
	230	80	4	23226 CA	23226 CAK	61500	70500	1200	1600
	230	80	4	23226	23226 K	57000	62500	1300	1800
	280	93	5	22326 CA	22326 CAK	88000	88500	1300	1600
	280	93	5	22326	22326 K	84000	80000	1400	1800
	140	210	53	3	23028 CD	23028 CDK	37000	45000	1500
210		69	3	24028 CA	24028 CAK30	45000	57000	1300	1600
225		68	3.5	23128 CA	23128 CAK	51500	60000	1200	1600
225		85	3.5	24128 CA	24128 CAK30	59500	73500	1200	1600
250		68	4	22228 CD	22228 CDK	57500	60500	1300	1700
250		88	4	23228 CA	23228 CAK	74000	83500	1100	1400
250		88	4	23228	23228 K	69000	77500	1200	1600
300		102	5	22328 CA	22328 CAK	103000	101000	1200	1500
300		102	5	22328	22328 K	97500	94000	1300	1700
150		225	56	3.5	23030 CD	23030 CDK	41500	51000	1400
	225	75	3.5	24030 CA	24030 CAK30	52500	68500	1100	1500
	250	80	3.5	23130 CA	23130 CAK	64000	75500	1100	1400
	250	100	3.5	24130 CA	24130 CAK30	76000	92500	1100	1400
	270	73	4	22230 CD	22230 CDK	67500	72000	1200	1600
	270	96	4	23230 CA	23230 CAK	86500	100000	1000	1300
	270	96	4	23230	23230 K	74500	83500	1100	1500
	320	108	5	22330 CA	22330 CAK	111000	113000	1100	1400
	320	108	5	22330	22330 K	110000	106000	1200	1500
	160	220	45	3	23932	23932 K	27100	38500	1500
240		60	3.5	23032 CD	23032 CDK	48000	60000	1300	1700
240		80	3.5	24032 CA	24032 CAK30	58500	76000	1100	1400
270		86	3.5	23132 CA	23132 CAK	75500	89500	1000	1300
270		109	3.5	24132 CA	24132 CAK30	88000	107000	1000	1300
290		80	4	22232 CD	22232 CDK	81000	85500	1100	1500
290		104	4	23232 CA	23232 CAK	97000	113000	1000	1200
290		104	4	23232	23232 K	86500	98500	1100	1400
340		114	5	22332 CA	22332 CAK	122000	126000	1000	1300
340		114	5	22332	22332 K	122000	120000	1100	1400

注(1)K錐形内孔 $\frac{1}{2}$ ・K30錐型内孔 $\frac{1}{4}$ 。

自動調心滾子軸承

內徑 25~85 mm

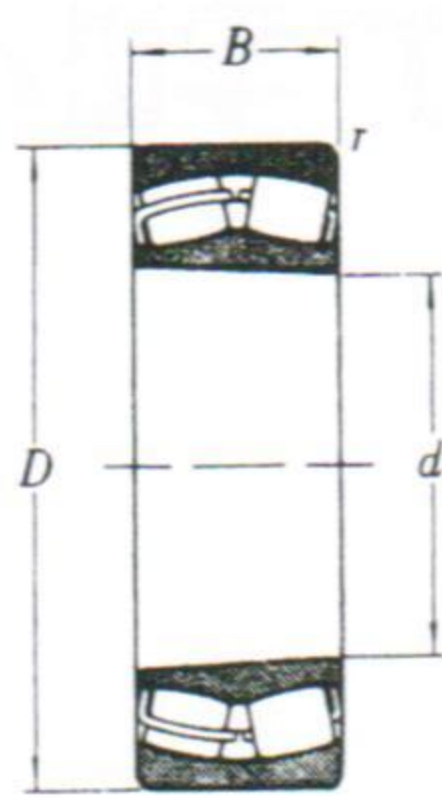
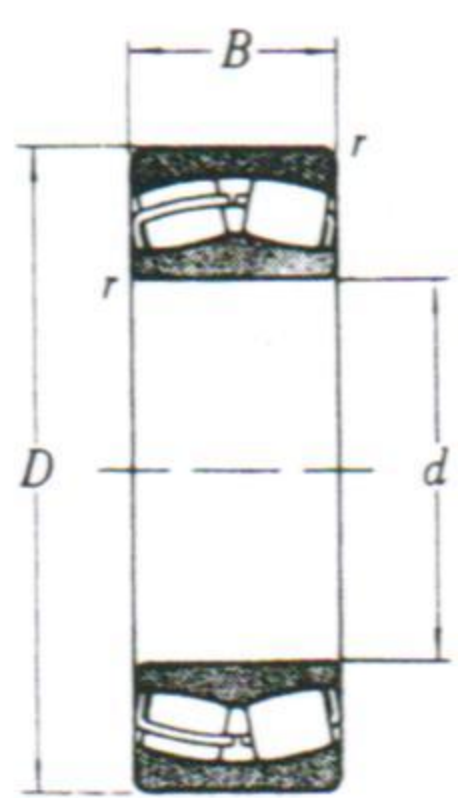

錐形內孔

付油孔・油溝

主要寸法(mm)				基本型號		基本定格荷重(kgf)		極限速率(rpm)	
d	D	B	r	圓形內孔	錐形內孔	C	Co	脂潤滑	油潤滑
25	62	17	2	21305 CD	21305 CDK	3800	2700	5300	6700
30	72	19	2	21306 CD	21306 CDK	4850	3600	4500	5600
35	80	21	2.5	21307 CD	21307 CDK	6300	5000	4000	5000
40	90	23	2.5	21308 CD	21308 CDK	7750	6100	3600	4500
	90	33	2.5	22308 CD	22308 CDK	10800	8650	4300	5300
45	100	25	2.5	21309 CD	21309 CDK	9150	7050	3200	4000
	100	36	2.5	22309 CD	22309 CDK	13100	11100	3800	4800
50	110	27	3	21310 CD	21310 CDK	10500	8400	2800	3800
	110	40	3	22310 CD	22310 CDK	16400	14000	3400	4300
55	100	25	2.5	22211 CD	22211 CDK	9250	7950	3600	4500
	120	29	3	21311 CD	21311 CDK	12400	10700	2600	3400
	120	43	3	22311 CD	22311 CDK	18500	16000	3200	4000
60	110	28	2.5	22212 CD	22212 CDK	11000	9650	3200	4000
	130	31	3.5	21312 CD	21312 CDK	14400	12600	2400	3200
	130	46	3.5	22312 CD	22312 CDK	21800	19100	2800	3600
65	120	31	2.5	22213 CD	22213 CDK	13500	12200	3000	3800
	140	33	3.5	21313 CD	21313 CDK	16000	14100	2200	2800
	140	48	3.5	22313 CD	22313 CDK	23500	20900	2600	3400
70	125	31	2.5	22214 CD	22214 CDK	14500	13300	2800	3600
	150	35	3.5	21314 CD	21314 CDK	19100	16800	2000	2600
	150	51	3.5	22314 CD	22314 CDK	27100	24400	2400	3100
75	130	31	2.5	22215 CD	22215 CDK	14500	13800	2600	3400
	160	37	3.5	21315 CD	21315 CDK	20900	18400	1900	2500
	160	55	3.5	22315 CD	22315 CDK	30000	27300	2300	2900
80	140	33	3	22216 CD	22216 CDK	16100	14900	2400	3100
	170	39	3.5	21316 CD	21316 CDK	23300	20600	1800	2300
	170	58	3.5	22316 CD	22316 CDK	34500	31500	2200	2700
85	150	36	3	22217 CD	22217 CDK	19100	17800	2300	2900
	180	41	4	21317 CD	21317 CDK	25700	23300	1700	2200
	180	60	4	22317 CD	22317 CDK	37000	33500	2000	2600

注(1)K錐型內孔 $\frac{1}{2}$

自動調心滾子軸承

內徑 90~120mm

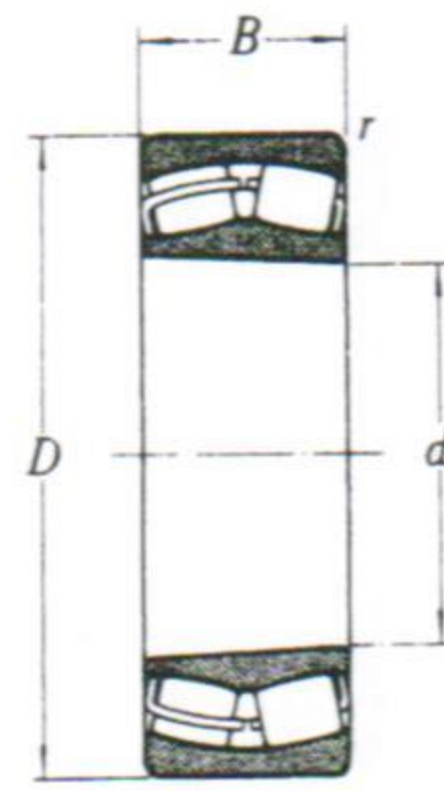
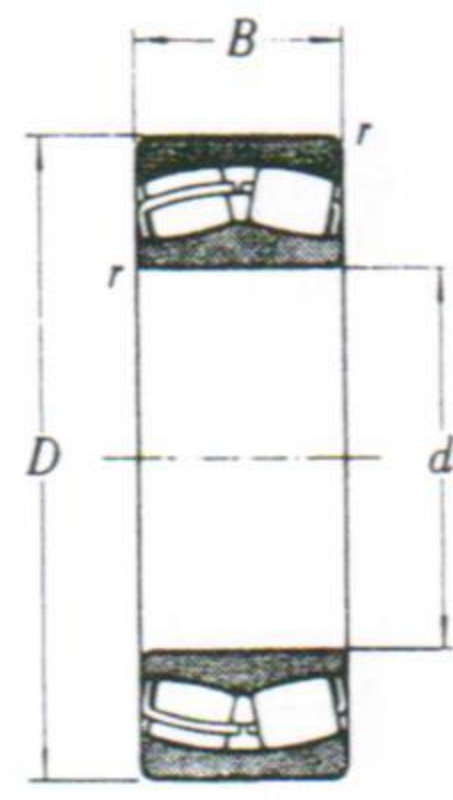

錐形內孔

付油孔・油溝

主要寸法(mm)				基本型號		基本定格荷重(kgf)		極限速率(rpm)	
d	D	B	r	圓形內孔	錐形內孔	C	Co	脂潤滑	油潤滑
90	160	40	3	22218 CD	22218 CDK	22800	21900	2200	2700
	190	43	4	21318 CD	21318 CDK	28500	26100	1600	2000
	190	64	4	22318 CD	22318 CDK	43000	39500	1900	2400
95	170	43	3.5	22219 CD	22219 CDK	26300	25400	2000	2600
	200	45	4	21319 CD	21319 CDK	31500	29000	1500	1800
	200	45	4	21319 A	21319 AK	29300	28300	1700	2200
	200	67	4	22319 CD	22319 CDK	46500	44500	1800	2300
	200	67	4	22319	22319 K	43500	40500	2000	2500
100	180	46	3.5	22220 CD	22220 CDK	29100	28400	1900	2400
	215	47	4	21320 CD	21320 CDK	35000	32500	1400	1800
	215	47	4	21320 A	21320 AK	32000	31500	1600	2000
	215	73	4	22320 CA	22320 CAK	53500	52000	1700	2200
	215	73	4	22320	22320 K	51500	47500	1900	2400
110	170	45	3	23022 CD	23022 CDK	26000	29500	1900	2400
	180	56	3	23122 CA	23122 CAK	34000	40000	1600	2000
	180	69	3	24122 CA	24122 CAK30	39000	45500	1600	2000
	200	53	3.5	22222 CD	22222 CDK	37500	37500	1700	2200
	200	69.8	3.5	23222 CA	23222 CAK	45500	49000	1400	1900
	200	69.8	3.5	23222	23222 K	45000	48000	1600	2100
	240	80	4	22322 CA	22322 CAK	66000	65000	1500	1900
	240	80	4	22322	22322 K	63500	59000	1700	2100
120	180	46	3	23024 CD	23024 CDK	27900	33000	1800	2200
	180	60	3	24024 CA	24024 CAK30	34000	42500	1500	1900
	200	62	3	23124 CA	23124 CAK	41000	46000	1400	1800
	200	80	3	24124 CA	24124 CAK30	49000	57500	1400	1800
	215	58	3.5	22224 CD	22224 CDK	43500	44500	1600	2000
	215	76	3.5	23224 CA	23224 CAK	56000	62000	1300	1700
	215	76	3.5	23224	23224 K	50000	55000	1500	1900
	260	86	4	22324 CA	22324 CAK	75500	74500	1400	1800
	260	86	4	22324	22324 K	75000	71000	1500	1900

注(1)K錐形內孔 $\frac{1}{2}$ ，K30錐形內孔 $\frac{3}{16}$ 。

自動調心滾子軸承

內徑 170~190mm

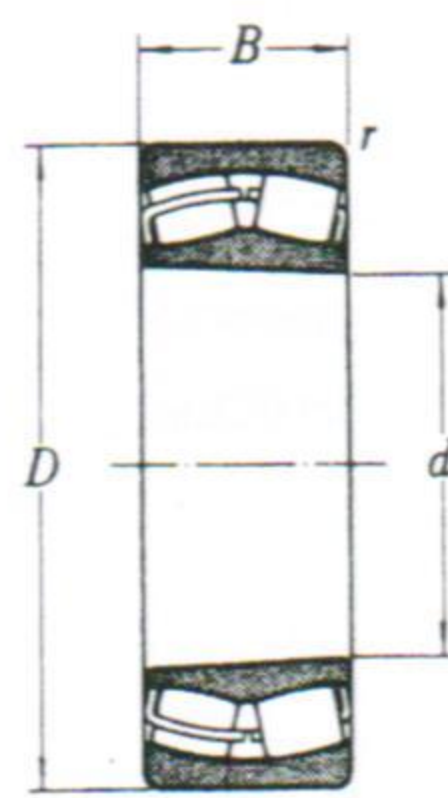
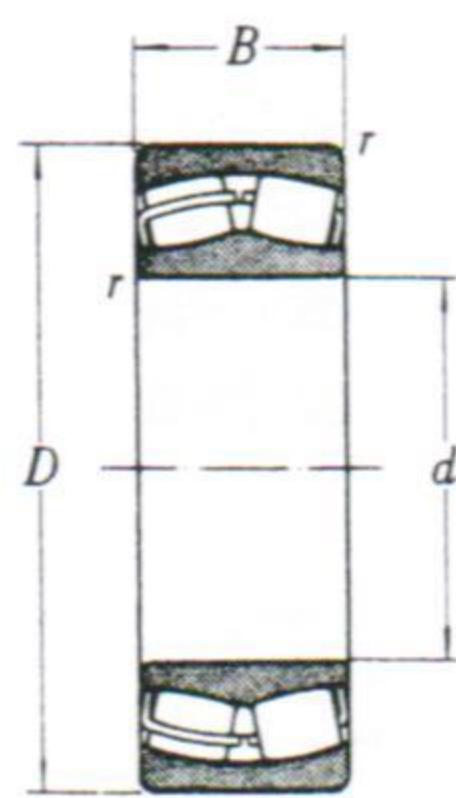

錐形內孔

付油孔・油溝

主要寸法(mm)				基本型號		基本定格荷重(kgf)		極限速率(rpm)		
d	D	B	r	圓形內孔	錐形內孔	C	Co	脂潤滑	油潤滑	
170	230	45	3	23934	23934 K	27800	40500	1400	1800	
	260	67	3.5	23034 CD	23034 CDK	56500	69000	1200	1500	
	260	90	3.5	24034 CA	24034 CAK30	70500	92000	1000	1300	
	280	88	3.5	23134 CA	23134 CAK	83500	100000	950	1300	
	280	109	3.5	24134 CA	24134 CAK30	90500	113000	950	1300	
	310	86	5	22234 CD	22234 CDK	88000	96500	1100	1400	
	310	86	5	22234 CA	22234 CAK	88000	96500	1100	1400	
	310	110	5	23234 CA	23234 CAK	106000	123000	900	1200	
	310	110	5	23234	23234 K	94500	108000	1000	1300	
	360	120	5	22334 CA	22334 CAK	141000	142000	950	1200	
	360	120	5	22334	22334 K	130000	128000	1100	1300	
	180	250	52	3	23936	23936 K	34500	49000	1300	1700
		280	74	3.5	23036 CD	23036 CDK	66500	80500	1100	1400
		280	100	3.5	24036 CA	24036 CAK30	85500	110000	950	1200
300		96	4	23136 CA	23136 CAK	93500	112000	900	1200	
300		96	4	23136	23136 K	83000	103000	1000	1300	
300		118	4	24136 CA	24136 CAK30	105000	130000	900	1200	
320		86	5	22236 CD	22236 CDK	90500	99500	1000	1300	
320		86	5	22236 CA	22236 CAK	90500	99500	1000	1300	
320		112	5	23236 CA	23236 CAK	115000	135000	850	1100	
320		112	5	23236	23236 K	104000	120000	950	1200	
380		126	5	22336 CA	22336 CAK	155000	157000	900	1100	
380		126	5	22336	22336 K	144000	143000	1000	1300	
190		260	52	3	23938	23938 K	35500	52000	1300	1600
		290	75	3.5	23038 CA	23038 CAK	68500	85500	1100	1300
	290	75	3.5	23038	23038 K	63500	83500	1200	1500	
	290	100	3.5	24038 CA	24038 CAK30	86500	116000	900	1200	
	320	104	4	23138 CA	23138 CAK	105000	129000	850	1100	
	320	104	4	23138	23138 K	93500	120000	950	1200	
	320	128	4	24138 CA	24138 CAK30	116000	143000	850	1100	
	320	128	4	24138	24138 K30	107000	134000	950	1200	
	340	92	5	22238 CD	22238 CDK	101000	111000	1000	1200	
	340	92	5	22238 CA	22238 CAK	101000	111000	1000	1200	
	340	120	5	23238 CA	23238 CAK	127000	151000	800	1000	
	340	120	5	23238	23238 K	111000	131000	850	1200	
	400	132	6	22338 CA	22338 CAK	169000	173000	850	1100	
	400	132	6	22338	22338 K	155000	155000	950	1200	

注(1)K錐型內孔 $\frac{1}{12}$ ，K30錐型內孔 $\frac{1}{30}$ 。

自動調心滾子軸承

內徑 200 ~ 220 mm

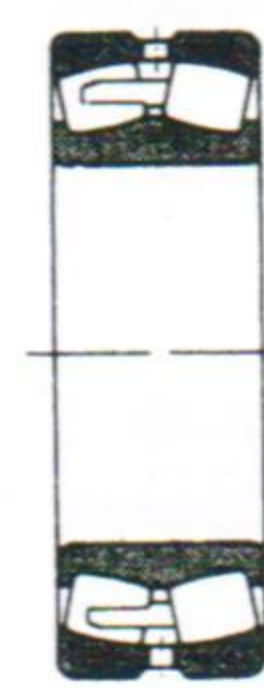
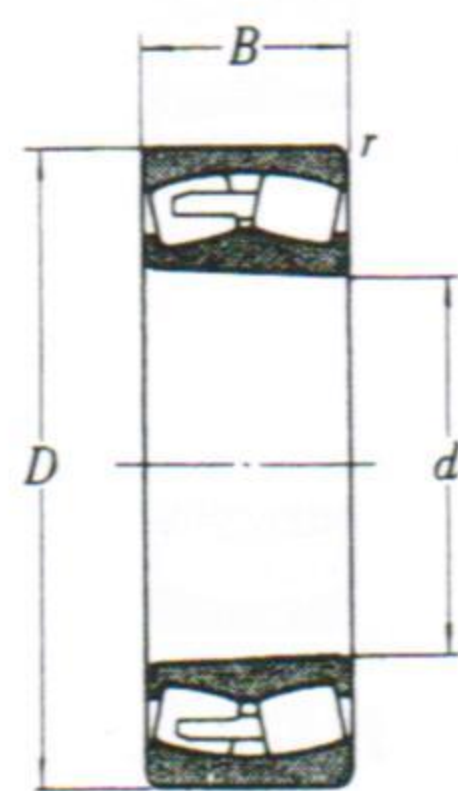
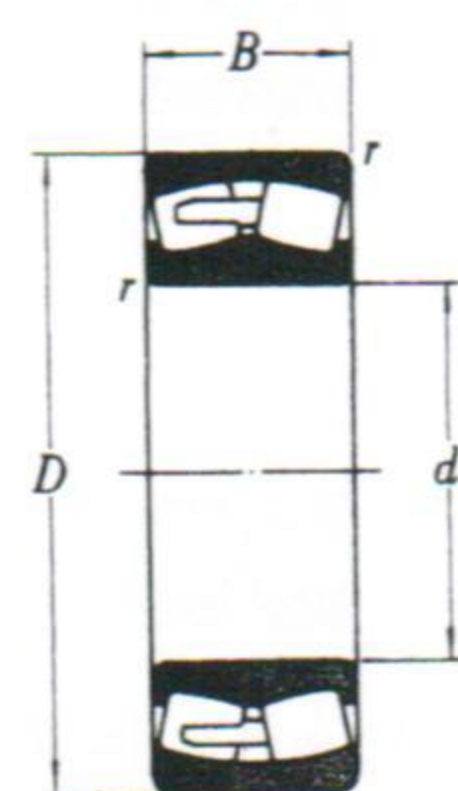

錐形內孔

付油孔・油溝

主要寸法(mm)				基本型號		基本定格荷重(kgf)		極限速率(rpm)		
d	D	B	r	圓形內孔	錐形內孔	C	Co	脂潤滑	油潤滑	
200	280	60	3.5	23940	23940 K	44500	63500	1200	1500	
	310	82	3.5	23040 CA	23040 CAK	83500	107000	1000	1300	
	310	82	3.5	23040	23040 K	71500	93500	1100	1400	
	310	109	3.5	24040 CA	24040 CAK30	101000	134000	850	1100	
	310	109	3.5	24040	24040 K30	89500	119000	950	1200	
	340	112	4	23140 CA	23140 CAK	120000	149000	800	1000	
	340	112	4	23140	23140 K	105000	133000	850	1100	
	340	140	4	24140 CA	24140 CAK30	139000	171000	800	1000	
	340	140	4	24140	24140 K30	118000	148000	850	1100	
	360	98	5	22240 CD	22240 CDK	115000	127000	900	1100	
	360	98	5	22240 CA	22240 CAK	115000	129000	900	1100	
	360	128	5	23240 CA	23240 CAK	147000	177000	750	1000	
	360	128	5	23240	23240 K	126000	151000	850	1100	
	420	138	6	22340 CA	22340 CAK	178000	197000	800	1000	
	420	138	6	22340	22340 K	170000	171000	900	1100	
	220	300	60	3.5	23944	23944 K	47000	69500	1100	1400
		340	90	4	23044 CA	23044 CAK	96500	125000	950	1200
		340	90	4	23044	23044 K	83500	113000	1000	1300
340		118	4	24044 CA	24044 CAK30	117000	157000	750	1000	
340		118	4	24044	24044 K30	103000	139000	850	1100	
370		120	5	23144 CA	23144 CAK	139000	173000	710	950	
370		120	5	23144	23144 K	125000	162000	800	1000	
370		150	5	24144 CA	24144 CAK30	159000	205000	710	950	
370		150	5	24144	24144 K30	139000	179000	800	1000	
400		108	5	22244 CA	22244 CAK	141000	157000	800	1000	
400		108	5	22244	22244 K	125000	138000	900	1100	
400		144	5	23244 CA	23244 CAK	178000	219000	710	900	
400		144	5	23244	23244 K	158000	194000	750	1000	
460		145	6	22344 CA	22344 CAK	208000	223000	750	900	
460		145	6	22344	22344 K	192000	195000	800	1000	

注(1)K錐型內孔 $\frac{1}{2}$ ，K30錐型內孔 $\frac{3}{30}$ 。

自動調心滾子軸承

內徑 240~260mm

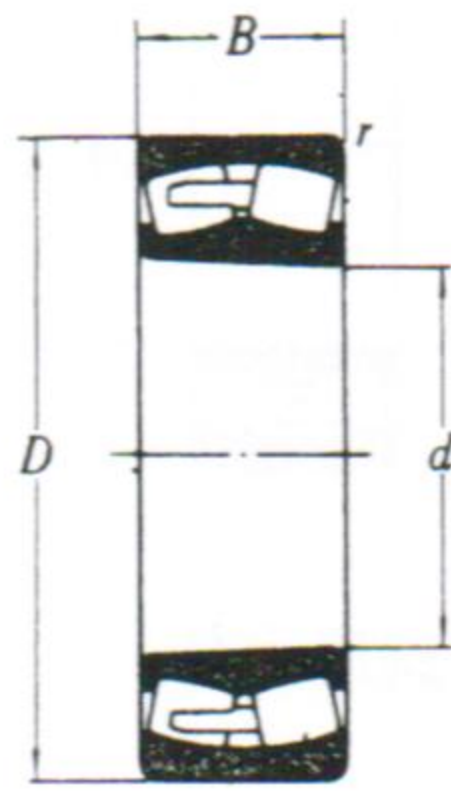
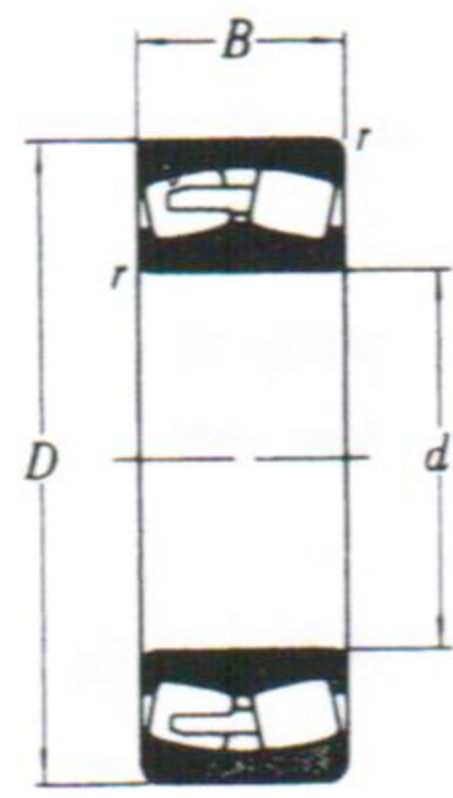

錐形內孔

付油孔・油溝

主要寸法(mm)				基本型號		基本定格荷重(kgf)		極限速率(rpm)		
d	D	B	r	圓形內孔	錐形內孔	C	Co	脂潤滑	油潤滑	
240	320	60	3.5	23948	23948 K	49500	76500	1000	1300	
	360	92	4	23048 CA	23048 CAK	103000	135000	850	1100	
	360	92	4	23048	23048 K	87500	121000	900	1200	
	360	118	4	24048 CA	24048 CAK30	123000	171000	710	900	
	360	118	4	24048	24048 K30	113000	160000	750	1000	
	400	128	5	23148 CA	23148 CAK	158000	199000	670	850	
	400	128	5	23148	23148 K	140000	183000	710	950	
	400	160	5	24148 CA	24148 CAK30	189000	242000	670	850	
	400	160	5	24148	24148 K30	161000	215000	710	950	
	440	120	5	22248 CA	22248 CAK	166000	186000	750	950	
	440	120	5	22248	22248 K	154000	174000	800	1000	
	440	160	5	23248 CA	23248 CAK	217000	262000	630	800	
	440	160	5	23248	23248 K	194000	242000	670	900	
	500	155	6	22348 CA	22348 CAK	242000	260000	670	850	
	500	155	6	22348	22348 K	220000	246000	750	950	
	260	360	75	3.5	23952	23952 K	67500	101000	900	1100
		400	104	5	23052 CA	23052 CAK	126000	163000	750	950
		400	104	5	23052	23052 K	117000	161000	850	1100
400		140	5	24052 CA	24052 CAK30	161000	222000	630	800	
400		140	5	24052	24052 K30	131000	178000	710	900	
440		144	5	23152 CA	23152 CAK	192000	241000	600	800	
440		144	5	23152	23152 K	175000	232000	670	850	
440		180	5	24152 CA	24152 CAK30	227000	300000	600	800	
440		180	5	24152	24152 K30	193000	251000	670	850	
480		130	6	22252 CA	22252 CAK	193000	218000	670	850	
480		130	6	22252	22252 K	176000	201000	750	900	
480		174	6	23252 CA	23252 CAK	243000	293000	560	710	
480		174	6	23252	23252 K	215000	263000	600	800	
540		165	8	22352 CA	22352 CAK	276000	300000	600	750	
540		165	8	22352	22352 K	250000	283000	670	850	

注(1)K錐型內孔 $\frac{1}{2}$ ，K30錐型內孔 $\frac{3}{30}$ 。

自動調心滾子軸承

內徑 280~320 mm

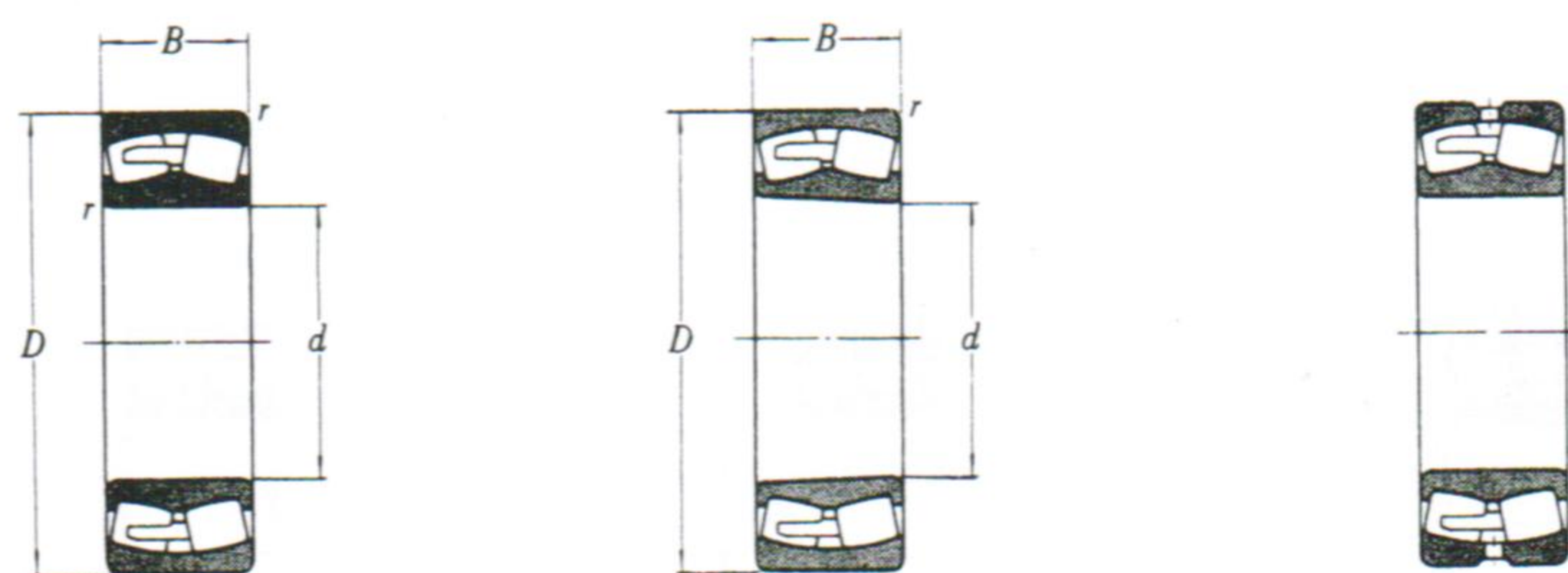

錐形內孔

付油孔・油溝

主要寸法(mm)				基本型號		基本定格荷重(kgf)		極限速率(rpm)	
d	D	B	r	圓形內孔	錐形內孔	C	Co	脂潤滑	油潤滑
280	380	75	3.5	23956	23956 K	72000	112000	850	1100
	420	106	5	23056 CA	23056 CAK	137000	185000	700	900
	420	106	5	23056	23056 K	122000	172000	800	1000
	420	140	5	24056 CA	24056 CAK30	166000	239000	600	750
	420	140	5	24056	24056 K30	150000	215000	670	850
	460	146	6	23156 CA	23156 CAK	206000	264000	560	750
	460	146	6	23156	23156 K	175000	238000	600	800
	460	180	6	24156 CA	24156 CAK30	234000	315000	560	750
	460	180	6	24156	24156 K30	193000	253000	600	800
	500	130	6	22256 CA	22256 CAK	202000	234000	630	800
	500	130	6	22256	22256 K	183000	213000	710	850
	500	176	6	23256 CA	23256 CAK	264000	320000	530	670
	500	176	6	23256	23256 K	221000	278000	560	750
	580	175	8	22356 CA	22356 CAK	310000	340000	560	710
	580	175	8	22356	22356 K	262000	294000	600	800
	300	420	90	4	23960	23960 K	92500	143000	750
460		118	5	23060 CA	23060 CAK	170000	233000	660	800
460		118	5	23060	23060 K	145000	202000	710	900
460		160	5	24060 CA	24060 CAK30	205000	291000	530	710
460		160	5	24060	24060 K30	187000	262000	600	750
500		160	6	23160 CA	23160 CAK	237000	305000	510	670
500		160	6	23160	23160 K	209000	286000	560	710
500		200	6	24160 CA	24160 CAK30	275000	370000	510	670
500		200	6	24160	24160 K30	230000	305000	560	710
540		140	6	22260 CA	22260 CAK	231000	272000	600	750
540		140	6	22260	22260 K	205000	237000	630	800
540		192	6	23260 CA	23260 CAK	305000	380000	480	630
540		192	6	23260	23260 K	252000	325000	530	670
320		440	90	4	23964	23964 K	93500	147000	710
	480	121	5	23064 CA	23064 CAK	174000	242000	620	750
	480	121	5	23064	23064 K	150000	215000	670	850
	480	160	5	24064 CA	24064 CAK30	216000	315000	530	670
	480	160	5	24064	24064 K30	191000	274000	560	710
	540	176	6	23164 CA	23164 CAK	272000	350000	480	600
	540	176	6	23164	23164 K	252000	350000	500	670
	540	218	6	24164 CA	24164 CAK30	315000	425000	480	600
	540	218	6	24164	24164 K30	274000	370000	500	670
	580	208	6	23264 CA	23264 CAK	345000	445000	450	560
	580	208	6	23264	23264 K	315000	410000	480	630

注(1)K錐型內孔 $\frac{1}{12}$ ，K30錐型內孔 $\frac{1}{30}$ 。

自動調心滾子軸承

內徑 340~380 mm

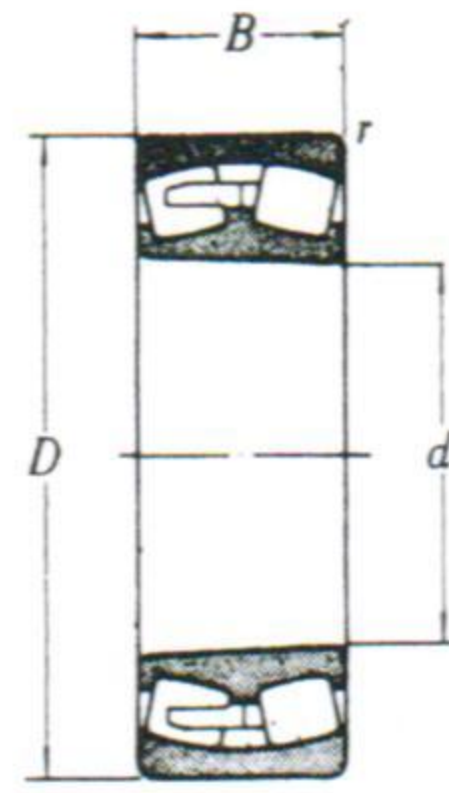
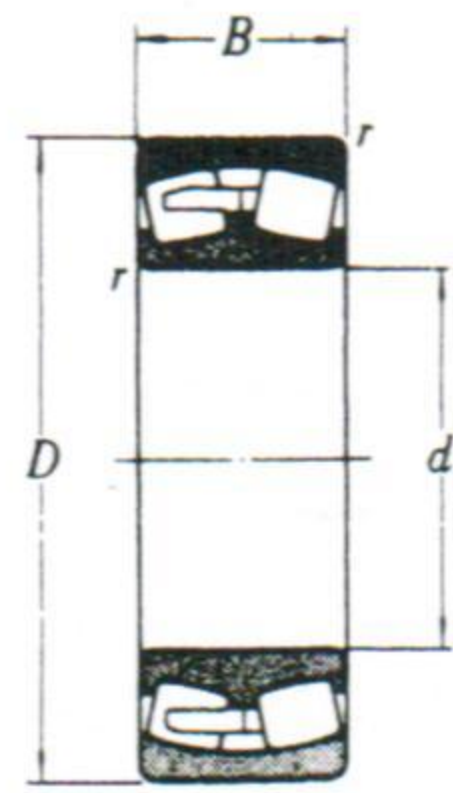

錐形內孔

付油孔・油溝

主要寸法(mm)				基本型號		基本定格荷重(kgf)		極限速率(rpm)		
d	D	B	r	圓形內孔	錐形內孔	C	Co	脂潤滑	油潤滑	
340	460	90	4	23968	23968 K	96000	155000	670	850	
	520	133	6	23068 CA	23068 CAK	202000	276000	560	710	
	520	133	6	23068	23068 K	189000	271000	600	800	
	520	180	6	24068 CA	24068 CAK30	259000	380000	480	600	
	520	180	6	24068	24068 K30	227000	335000	500	670	
	580	190	6	23168 CA	23168 CAK	320000	420000	450	560	
	580	190	6	23168	23168 K	280000	385000	480	630	
	580	190	6	24168 CA	24168 CAK30	375000	505000	450	560	
	580	243	6	24168	24168 K30	320000	435000	480	630	
	620	224	8	23268 CA	23268 CAK	390000	505000	400	530	
	620	224	8	23268	23268 K	360000	465000	450	600	
	360	480	90	4	23972	23972 K	100000	167000	630	800
		540	134	6	23072 CA	23072 CAK	212000	296000	530	670
		540	134	6	23072	23072 K	193000	281000	600	750
540		180	6	24072 CA	24072 CAK30	260000	385000	440	560	
540		180	6	24072	24072 K30	233000	345000	480	630	
600		192	6	23172 CA	23172 CAK	340000	455000	430	530	
600		192	6	23172	23172 K	300000	425000	450	600	
600		243	6	24172 CA	24172 CAK30	380000	530000	430	530	
600		243	6	24172	24172 K30	320000	440000	450	600	
650		232	8	23272 CA	23272 CAK	415000	535000	400	500	
650		232	8	23272	23272 K	380000	495000	430	560	
380		520	106	5	23976	23976 K	129000	210000	600	750
		560	135	6	23076 CA	23076 CAK	222000	320000	500	630
		560	135	6	23076	23076 K	197000	292000	560	710
	560	180	6	24076 CA	24076 CAK30	272000	415000	420	560	
	560	180	6	24076	24076 K30	252000	380000	450	600	
	620	194	6	23176 CA	23176 CAK	355000	480000	400	500	
	620	194	6	23176	23176 K	305000	430000	430	560	
	620	243	6	24176 CA	24176 CAK30	385000	540000	400	500	
	620	243	6	24176	24176 K30	345000	485000	430	560	
	680	240	8	23276 CA	23276 CAK	470000	605000	380	480	
	680	240	8	23276	23276 K	395000	515000	400	530	

注(1)K錐型內孔 $\frac{1}{2}$ ，K30錐型內孔 $\frac{3}{30}$ 。